

ISL9519TQFNEVAL2Z Evaluation Board Setup Procedure

Introduction

The ISL9519 is a highly integrated battery charger controller for Li-ion/Li-ion polymer batteries with SMBus interface controlling system voltage, charge current and input current limiting. The evaluation board includes a USB to SMBus interface to allow users to control the ISL9519 from a Personal Computer.

ISL9519TQFNEVAL2Z vs ISL9519EVAL1Z

ISL9519TQFNEVAL2Z is designed for input voltage below 7V (i.e., 5V input) but has protection from input voltage up to 22V. It differs from the design for input voltage >7V (ISL9519EVAL1Z) in 3 ways:

1. ISL9519TQFNEVAL2Z drives both input PFETs with AGATE to turn both ON when adapter voltage is high. ISL9519EVAL1Z drives SGATE ON only when input current is >300mA.
2. ISL9519TQFNEVAL2Z has a circuit that connects input voltage to VDD when the input is less than 5.2V to bypass the internal LDO.
3. ISL9519TQFNEVAL2Z has a zener to protect ADET from voltages >7V absolute maximum if the input voltage is >9.5V.

What's Inside

This Evaluation Board Kit contains the following materials:

- Qty (1) ISL9519TQFNEVAL2Z Evaluation Board
- Qty (1) USB cable

What is Needed

The following materials are recommended to perform testing:

- One adjustable 25V/6A power supply
- Two adjustable electronic loads with constant current mode and constant voltage mode
- One Volt Meter
- One 500MHz four-channel oscilloscope with voltage and current probes
- A Personal Computer (PC) with ISL9519 control software and drivers (available at www.intersil.com)

Note: The National Instruments Runtime Engine must be installed before connecting the evaluation board to your PC. The Runtime Engine contains driver files required by the New Hardware Wizard.

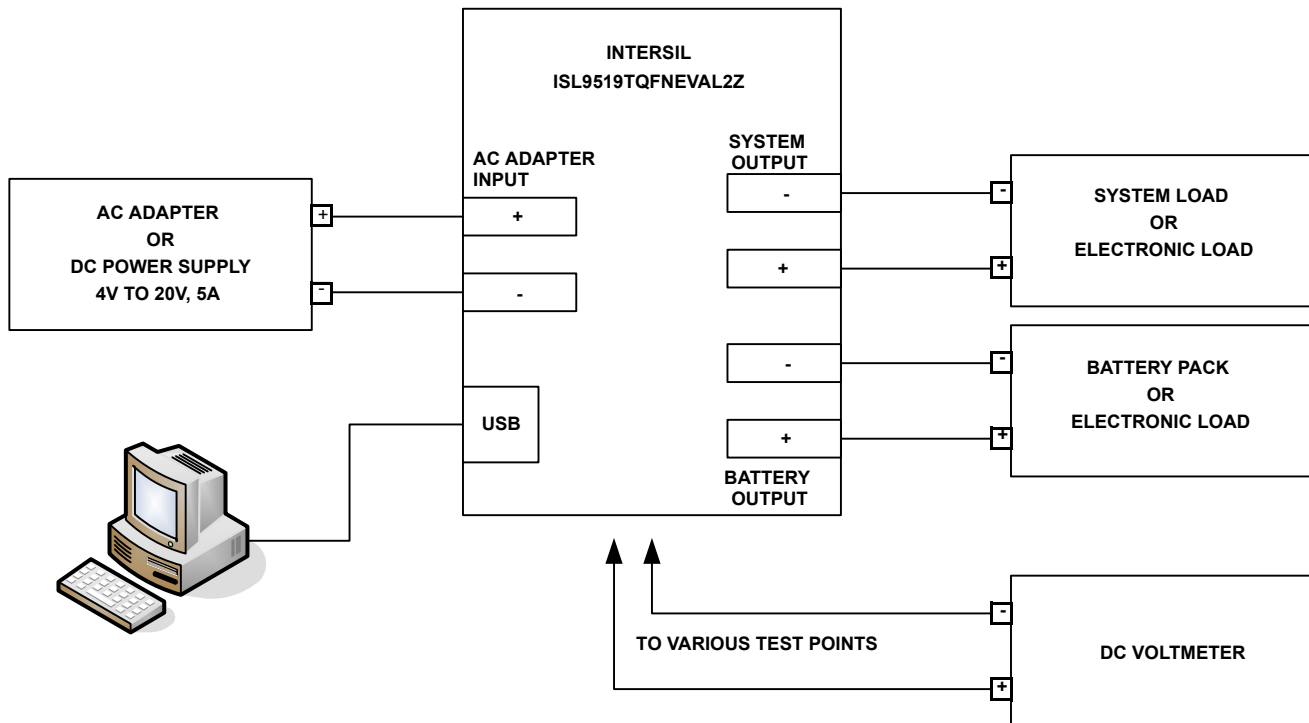

FIGURE 1. ISL9519TQFNEVAL2Z HARDWARE CONNECTION DIAGRAM

Application Note 1570

Install the Software

1. Download the ISL9519 CONTROL Software Installer.zip file from www.intersil.com. Extract it to a folder on your PC. Navigate to the folder and double click the "Autoexec.exe" file.
2. Click on the "Install or Uninstall ISL9519 CONTROL Software" to run the Installation Wizard.
3. You should now see a window as shown in Figure 3.

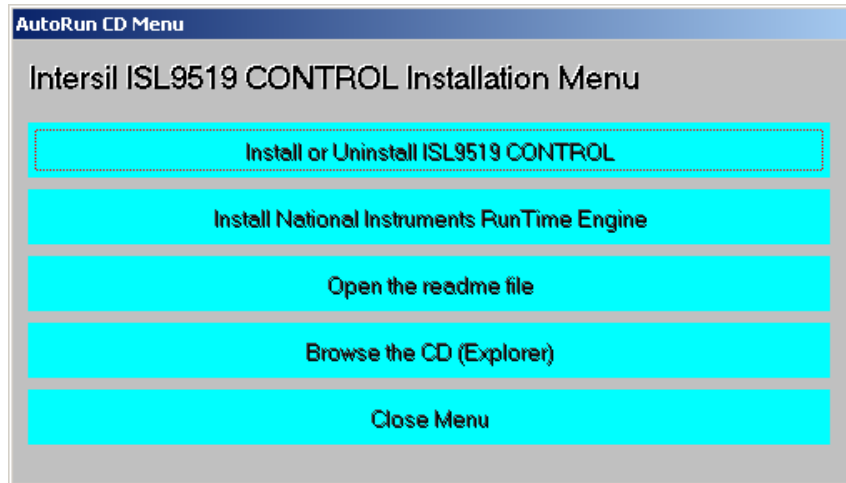

FIGURE 2. AUTORUN CD MENU



FIGURE 3. INSTALLATION WIZARD

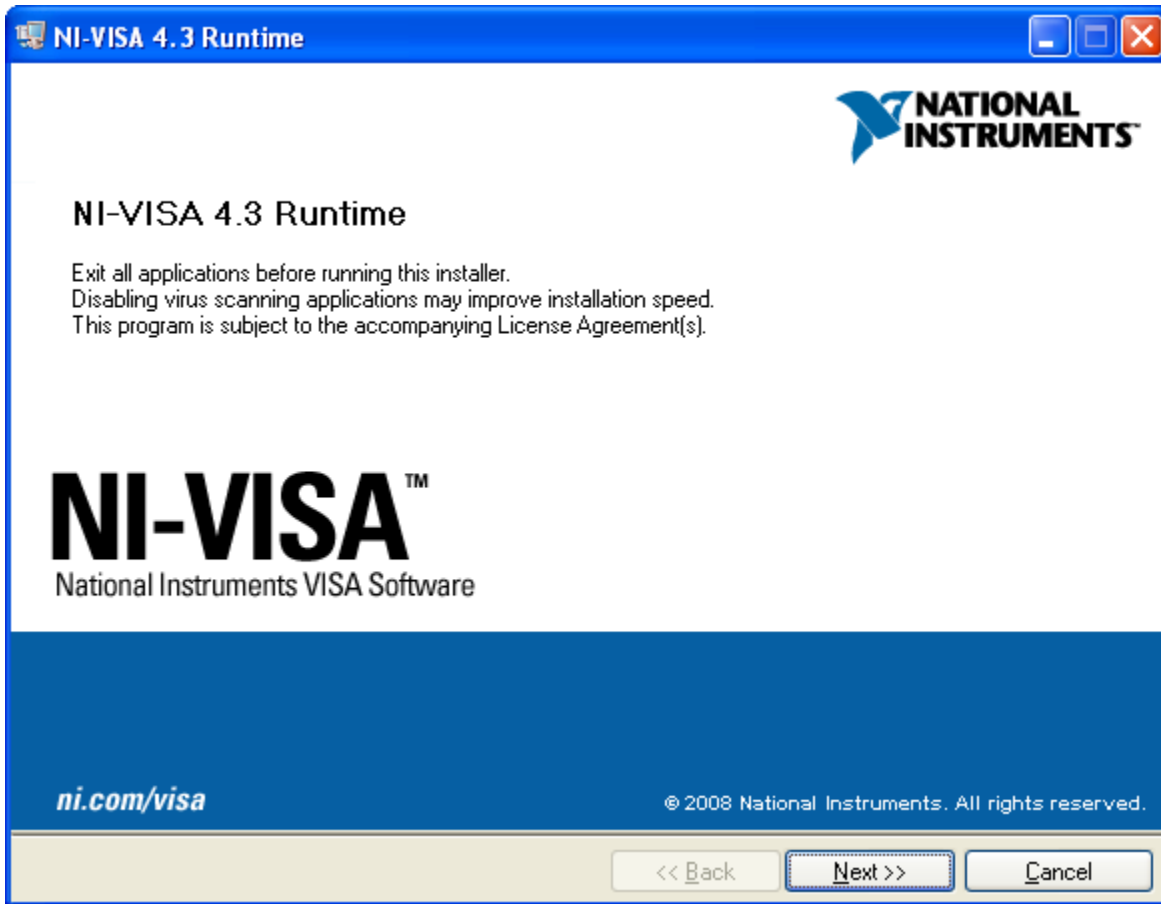

FIGURE 4. NATIONAL INSTRUMENTS RUNTIME ENGINE INSTALLATION WIZARD

In most PCs, the National Instruments Runtime Engine will be installed automatically after the ISL9519 software. You should see the window as shown in Figure 4.

Follow the instructions to install the Runtime Engine. If it does not run automatically, click "Install National Instruments Runtime Engine" on the ISL9519 Control Software Installation Menu (see Figure 2). After installation, click on the "Close Menu" button.

Application Note 1570

Driver Installation

After installing the National Instruments Runtime Engine, connect the ISL9519TQFNEVAL2Z evaluation board to the USB port of your PC.

Note: The SMBus part of the ISL9519 and the USB-SMBus interface are powered by the 5V from the USB port on the PC. It is

not necessary to have other power supplies connected to the evaluation board to read or write to the ISL9519.

When WINDOWS detects new hardware, the new hardware wizard should appear. Direct it to look for the driver information file in the "ISL9519 CONTROL Software Installer" folder (extracted from the downloaded file). In some systems, it may be necessary to specify the driver information file (USB-I2C_WDM.inf).

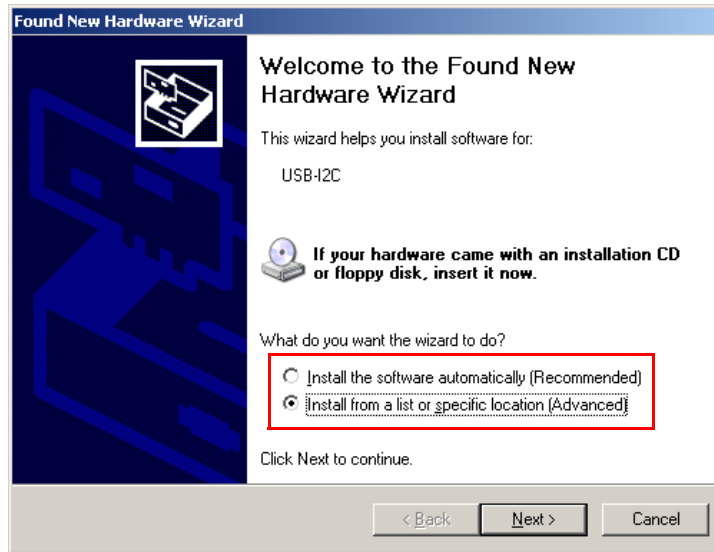

FIGURE 5. SELECT "INSTALL FROM A SPECIFIC LOCATION"

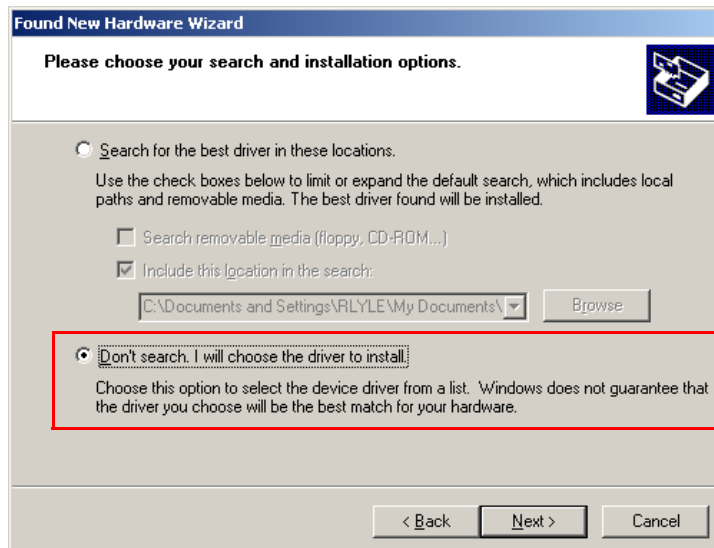

FIGURE 6. SELECT "DON'T SEARCH"

Application Note 1570

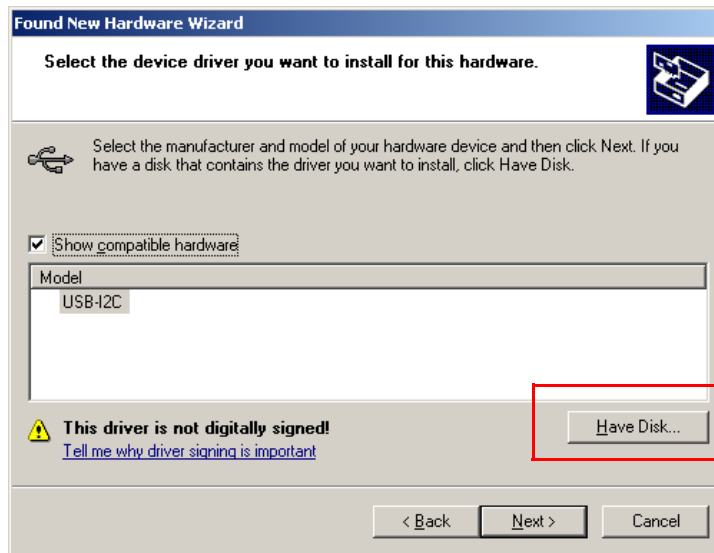

FIGURE 7. CLICK ON THE “HAVE DISK” BUTTON

Then hit “Open” and “Next” several times. The hardware wizard should indicate that files are being copied. After file transfer, the hardware wizard should indicate that the new hardware is ready to use.

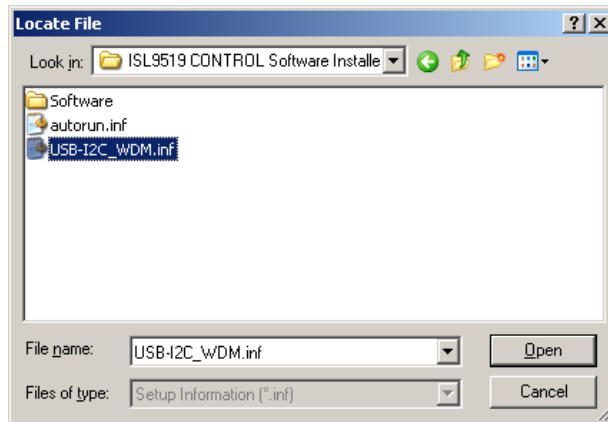

FIGURE 8. BROWSE TO THE FOLDER EXTRACTED FROM THE ZIP FILE AND SELECT “USB-I2C_WDM.INF”

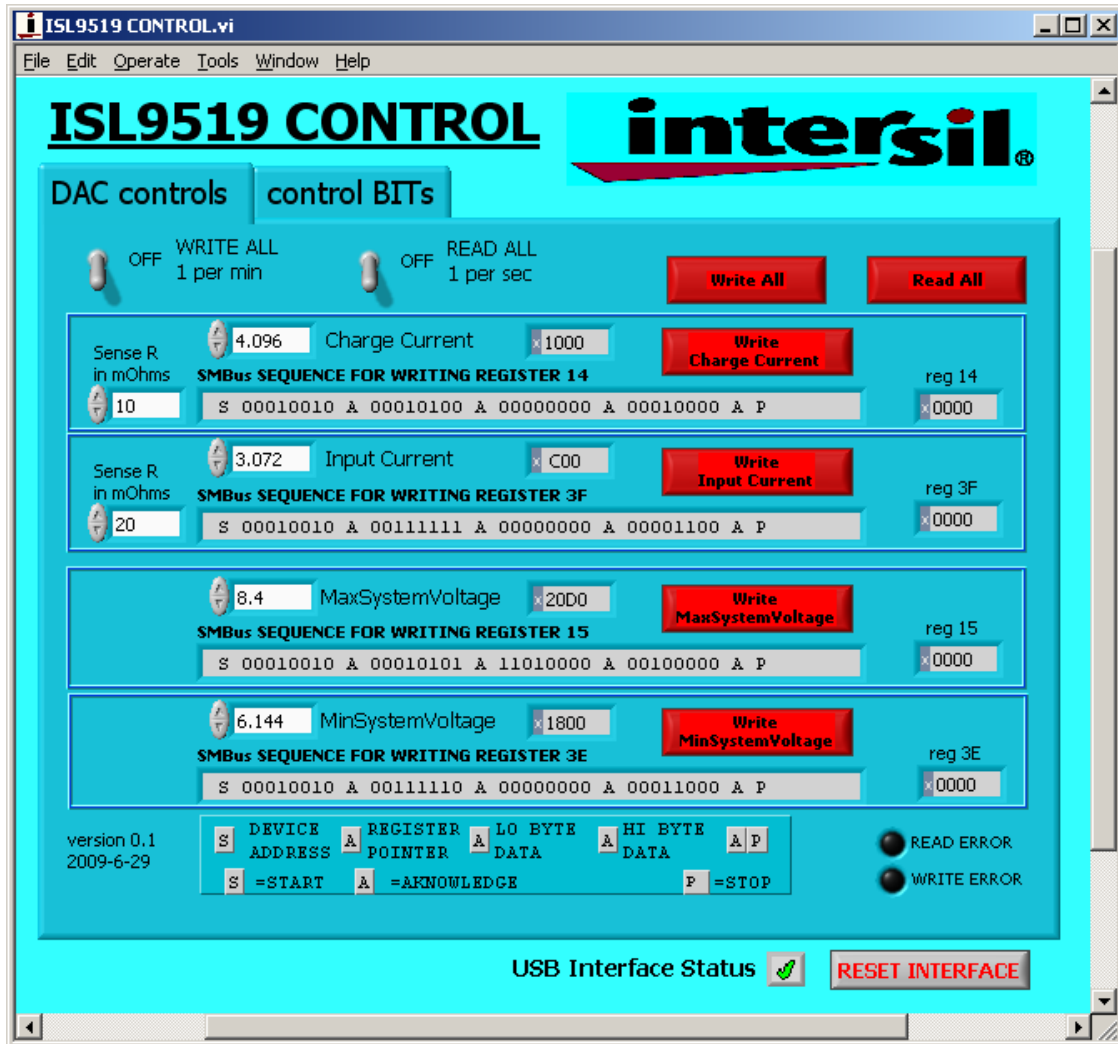

FIGURE 9. ISL9519 CONTROL SOFTWARE SCREEN SHOT

Run the ISL9519 Application

ISL9519 should now appear in your START/ALL Programs list. Click on it to run the application.

Figure 9 shows a screen shot of the ISL9519 user interface.

Enable the Output

When power is applied to the ISL9519, the Charge Current and Charge Voltage Registers are 0x0000 and the output is disabled. The output is enabled by writing valid, non-zero values to these 2 registers. See the ISL9519 data sheet for valid values ([FN6773](#)).

The ISL9519 is also disabled if the ACIN pin is below 3.2V. The minimum input voltage can be adjusted on the evaluation board by changing R₆ or R₇ (see Figure 15).

Description of the User Interface Controls and Display Information

Clicking the “Write All” button will write the indicated SMBus sequences to Registers 14, 15, 3F and 44 in the ISL9519.



Note: The SMBus part of the ISL9519 and the USB interface are powered by the 5V from the USB port on the PC. It is not necessary to have other power supplies connected to the evaluation board to read or write to the ISL9519.

Clicking on the “Read All” button will read all 6 registers in the ISL9519 and display the results in the grey indicators below the Read All button.



Application Note 1570

If the device and the interface are operating normally, the VendorID (reg FE) and the DeviceID (reg FF) will display as follows:

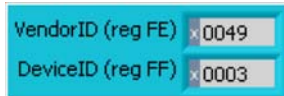

If the VendorID (reg FE) and DeviceID (reg FF) remain 0000 it indicates a communication problem.

If the Visa resource name is blank, it indicates a problem with the USB communication.

Clicking on the “RESET INTERFACE” button may correct the problem. If not, try closing the software, remove power and USB connections from the evaluation board, then reconnect and restart.

Note the register contents are updated ONLY when the Read All button is clicked.



The Write Charge Current Button sends only the charge current to the ISL9519. Other registers are unchanged.



The small white window next to “Charge Current” accepts inputs in Amps, and converts them to the hexadecimal (hex) value to be written to the ISL9519 in the grey window. The hex value depends on the value entered in Sense R. The value in the white window will be forced to the nearest valid number that can be produced by the DAC in the ISL9519. That is, after entering 4 and hitting the enter key, the display will change to 3.968. After entering 4.1 and hitting the enter key, the display will change to 4.096. The value can be incremented and decremented with the up/down arrows at the left of the window.



The Sense R inputs are used to calculate the hexadecimal (hex) values and the SMBus sequences for the Charge Current limit and Input Current limit entered in the white boxes. The evaluation board is built with 10mΩ sense resistors. If you change them to another value, enter the new value to get correct calculations.

After entering a number in the white box, hitting the enter key or clicking on another area will enter the value and the resulting hex value and the SMBus sequence will be calculated and displayed.



S = the Start condition, A = the Acknowledge, P = the Stop condition.

Note: The LO byte is sent first. The HI byte is sent second.

When writing 0x41A0, 0xA0 is written first and 0x41 is sent second.

Important Note: The SMBus commands are NOT sent until one of the WRITE buttons is clicked (i.e., Write All or Write Charge Current).

Important Note: Max System Voltage Commands that a much higher than the voltage for the number of cells selected by the CELL pin are ignored (not acknowledged). Please refer to the Max System Voltage section of the data sheet for details.

The Write MaxSystem Voltage button writes only the MaxSystem Voltage register. Other registers are unchanged.

The small white window accepts Max System Voltage (in Volts) and calculates the hexadecimal value and the SMBus sequence to write to the ISL9519. The SMBus command is sent when the Write MaxSystem Voltage or Write All button is clicked. See Figure 12.

The Write Input Current button writes only the Charge Current register. Other registers are unchanged. The small white window accepts Input Current Limit in Amps and calculates the hex value and the SMBus sequence to be written to the ISL9519. The Sense R input is used to calculate the hex value and the SMBus sequence. The SMBus command is sent when the Write Input Current or Write All button is clicked. See Figure 13.

The ISL9519 will shut down unless it receives MaxSystem Voltage or Charge Current commands every 175s. This is a safety feature that prevents overcharging batteries if bus master has stopped functioning. A toggle switch can be set to tell the software to write all commands every 60 seconds.

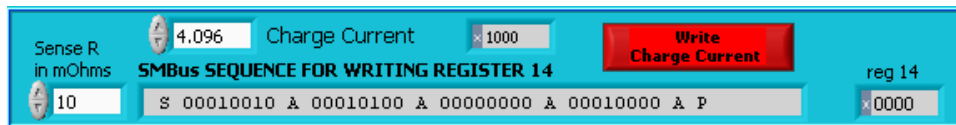
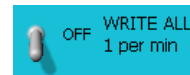

FIGURE 10. WRITE CHARGE CURRENT

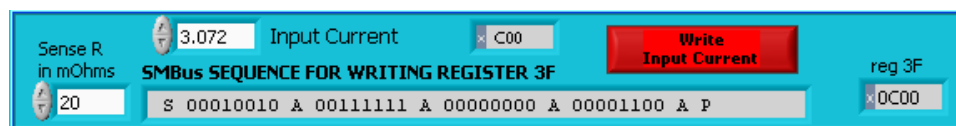

FIGURE 11. WRITE INPUT CURRENT

Application Note 1570



FIGURE 12. WRITE MAX SYSTEM VOLTAGE



FIGURE 13. WRITE MIN SYSTEM VOLTAGE

Interface Troubleshooting

When the evaluation board is connected to the PC by a USB cable and communicates with the interface on the eval board, a green check mark will appear next to the USB Interface Status.

If there is a red X instead of the green check, it indicates a problem with communication between the PC and the micro controller on the evaluation board. Check and correct the connection of the USB cable to your PC and the evaluation board. Click on the "RESET INTERFACE" button.

If you still get a red X, close and restart the ISL9519 control software.

If you still get a red X, open the Device Manager (Control Panel/System/Device Manager) with the ISL9519QFNEVAL2Z evaluation board connected to your USB port. You should see a device named "NI-VISA USB Device". If it is not in the list of devices, the driver may not be correctly installed. Run the New Hardware wizard.

If you still get a red X, contact an Intersil Field Application Engineer for assistance.

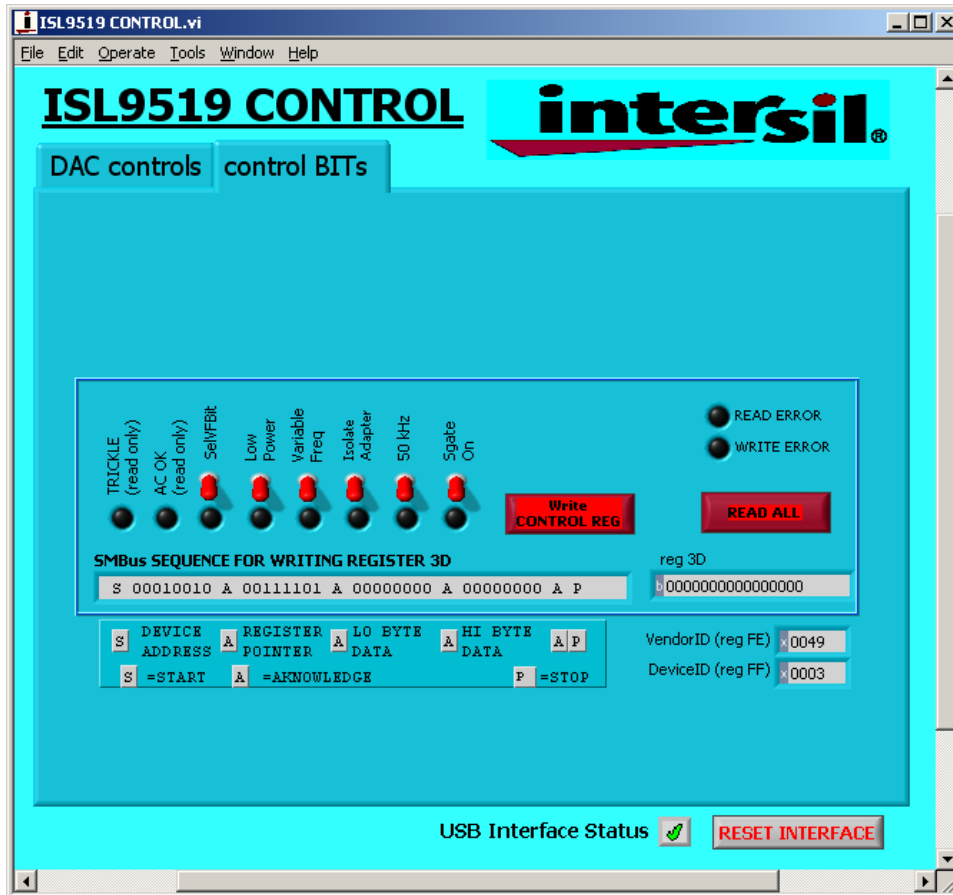

FIGURE 14. WRITE THE CONTROL REGISTER

ISL9519TQFNEVAL2Z Schematics (Continued)

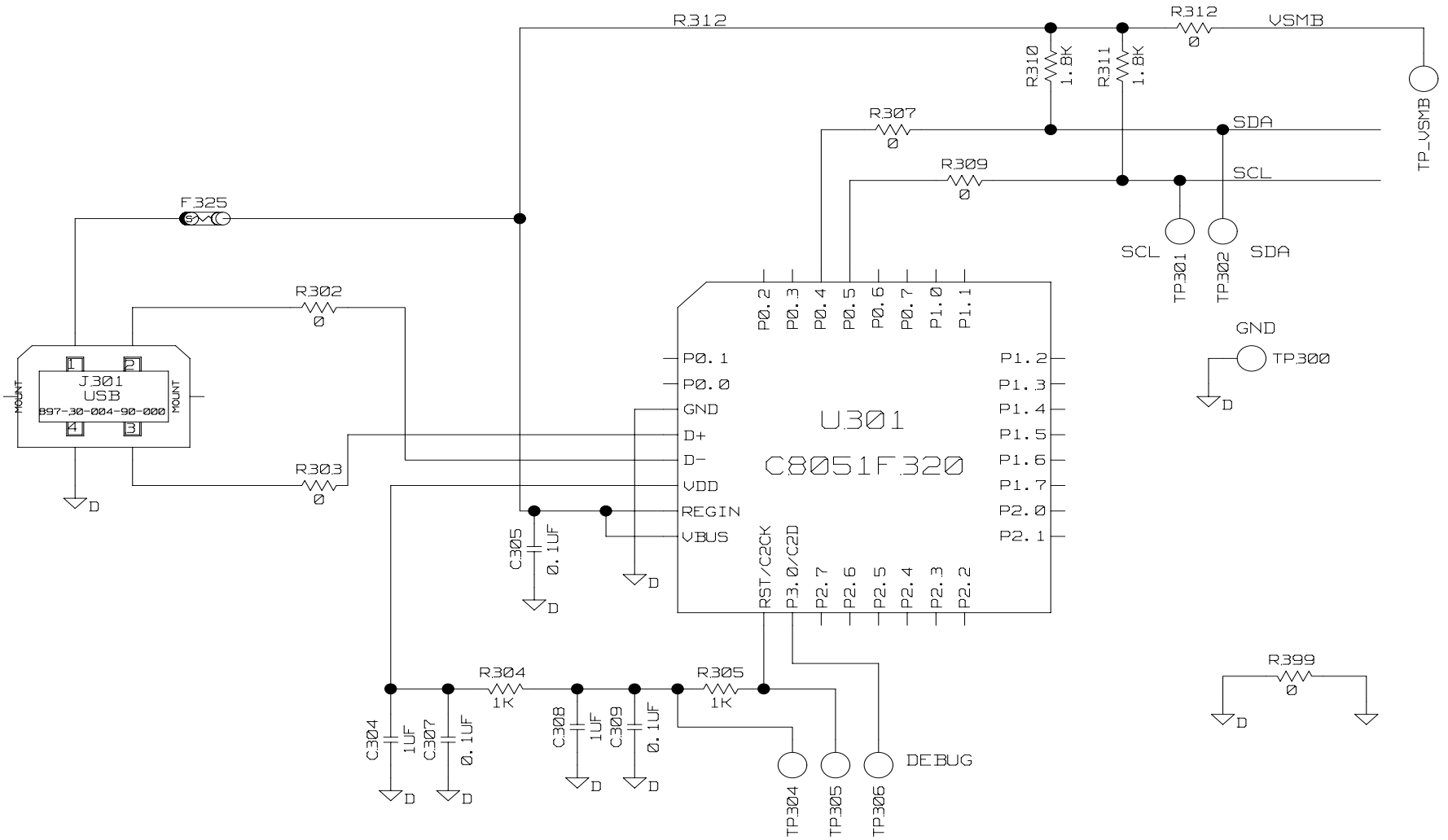

FIGURE 16. ISL9519TQFNEVAL2Z REV C SCHEMATIC

Application Note 1570

TABLE 1. ISL9519TQFNEVAL2Z REV C EVALUATION BOARD BILL OF MATERIALS

NO.	REF DES	QTY	DESCRIPTION	MANUFACTURER
1	C1	1	CAP, SMD, 0603, 470pF, 25V, 5%, X7R, ROHS	GENERIC
2	C10, C11, C304, C308, CF21	5	CAP, SMD, 0603, 1.0µF, 25V, 10%, X5R, ROHS	GENERIC
3	C13, C22, C52	3	CAP, SMD, 0805, 1.0µF, 25V, 10%, X5R, ROHS	GENERIC
4	C15	1	CAP, SMD, 1206, 10µF, 25V, 10%, X5R, ROHS	GENERIC
5	C9	1	C4532X7R1E106M (C Series Cap)	TDK
6	C2, C6	2	CAP, SMD, 0603, 1000pF, 25V, 5%, X7R, ROHS	GENERIC
7	C3, C4, C7, C12, C23, C24, C39, CF12, CF13, C305, C307, C309	12	CAP, SMD, 0603, 0.1µF, 25V, 10%, X7R	GENERIC
8	C8	1	CAP, SMD, 0603, 0.22µF, 25V, 10%, X7R, ROHS	GENERIC
9	CF11	1	CAP, SMD, 0603, 0.047µF, 25V, 5%, X7R, ROHS	GENERIC
10	Q_BGATE	1	FDS4465SCT	FAIRCHILD
11	Q_AGATE, Q_SGATE	2	HAT1127H	RENESAS
12	R1	1	RES, SMD, 0603, 3k, 1/10W, 1%, TF, ROHS	GENERIC
13	R11, R12, R13, R18, R22, R58, R61, R71, R72	9	RES, SMD, 0603, 10k, 1/10W, 1%, TF, ROHS	GENERIC
14	R15, R304, R305	3	RES, SMD, 0603, 1k, 1/10W, 1%, TF, ROHS	GENERIC
15	R17	1	RES, SMD, 0603, 4.7Ω, 1/10W, 1%, TF, ROHS	GENERIC
16	R2	1	RES, SMD, 0603, 56k, 1/10W, 1%, TF, ROHS	GENERIC
17	R28	1	RES, SMD, 0603, 100Ω, 1/10W, 1%, TF, ROHS	GENERIC
18	R24, R25, R26, RF22, R302, R303, R307, R309, R312, R399	10	RES, SMD, 0603, 0Ω, 1/10W, 1%, TF, ROHS	GENERIC
19	R27	1	RES, SMD, 2010, 0Ω, 1/2W, 5%, TF, ROHS	GENERIC
20	R310, R311	2	RES, SMD, 0603, 1.8k, 1/10W, 1%, TF, ROHS	GENERIC
21	R7, R9, R21	3	RES, SMD, 0603, 100k, 1/10W, 1%, TF, ROHS	GENERIC
22	R44	1	RES, SMD, 0603, 33Ω, 1/10W, 1%, TF, ROHS	GENERIC
23	R6	1	RES, SMD, 0603, 35.7k, 1/10W, 1%, TF, ROHS	GENERIC
24	R70	1	RES, SMD, 0805, 2.43k, 1/10W, 1%, TF, ROHS	GENERIC
25	RF11, RF12	2	RES, SMD, 0603, 10Ω, 1/10W, 1%, TF, ROHS	GENERIC
26	RF21	1	RES, SMD, 0603, 2.2Ω, 1/10W, 1%, TF, ROHS	GENERIC
27	RS1	1	0.02, LRC-LRF2010-01-R020-F	IRC
28	RS2	1	0.01, LRC-LRF2010LF-01-R010-F	IRC
29	U1	1	ISL9519HRTZ	INTERSIL
30	C14, C17, C18, C19, C20, C26, C28, C30, C32, C33, C35, C37	12	20TQC47M, 47µF, TQC Series Hi-Volt Low ESR Capacitor	SANYO
31	F325	1	MICROSMD050F, PolySwitch SM Resettable Fuse	RAYCHEM-TYCO
32	L1	1	IHLP-5050CE-01-4R7M, 4.7µH, 13mm SMD Inductor	VISHAY
33	Q1, Q2	2	RJK0305, N-Channel Power MOSFET	HITACHI
34	Q44, Q70	2	BSS84TA, P-Channel MOSFET	Fairchild
35	Q71	1	MMBT3906, PNP Transistor	Fairchild
36	U301	1	C8051F320-GQ/PROG-REV.02 General Purpose MicroControllers	SILICON LABORATORIES
37	Z70, Z71	2	BZX84C5V1LT1, Zener Diode	Fairchild
38	C21, C25, C27, C29, C31, C34, C36, C38, C40, R3, R38, Q3, Q4	13	OPEN	

Application Note 1570

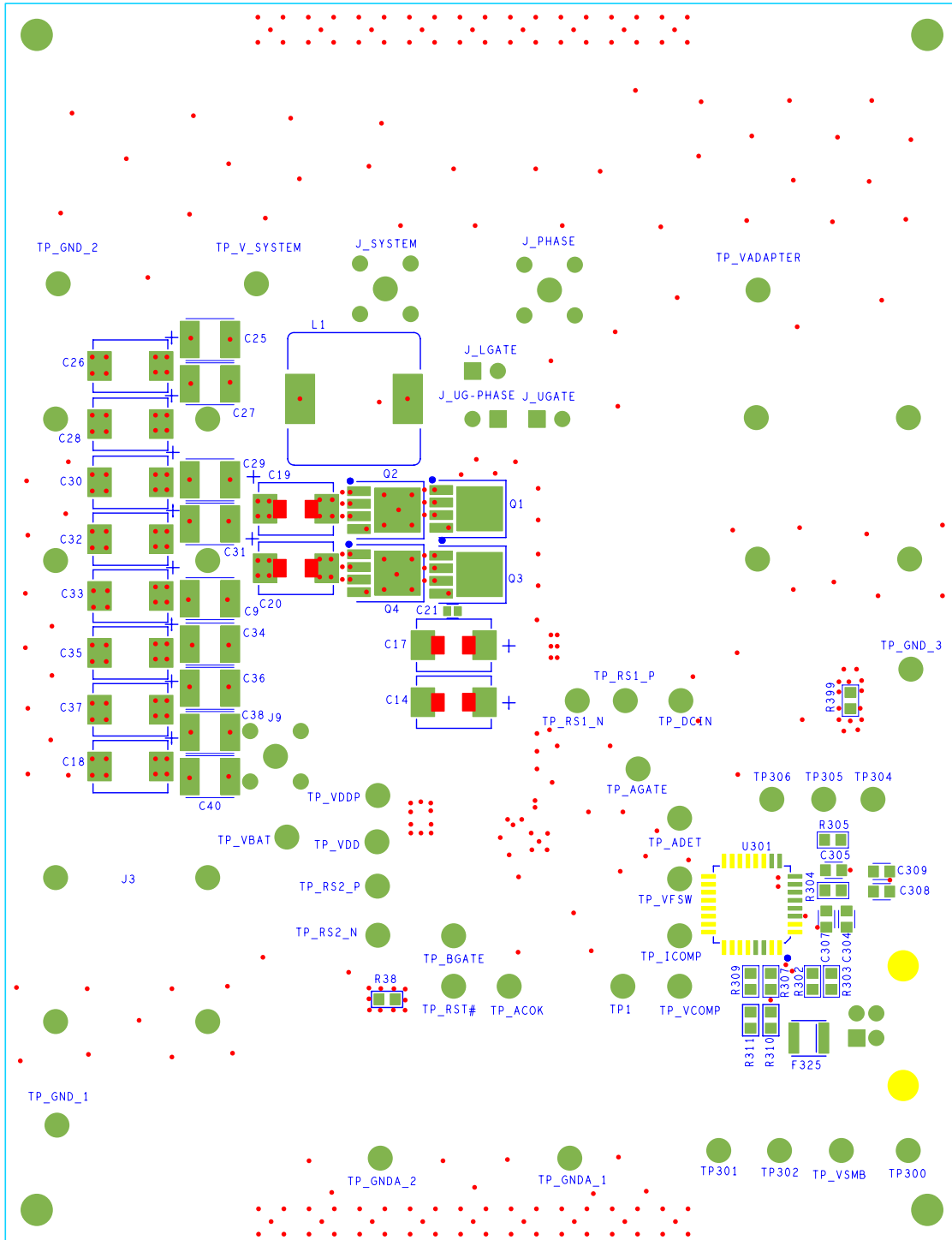

FIGURE 18. BOTTOM SILKSCREEN

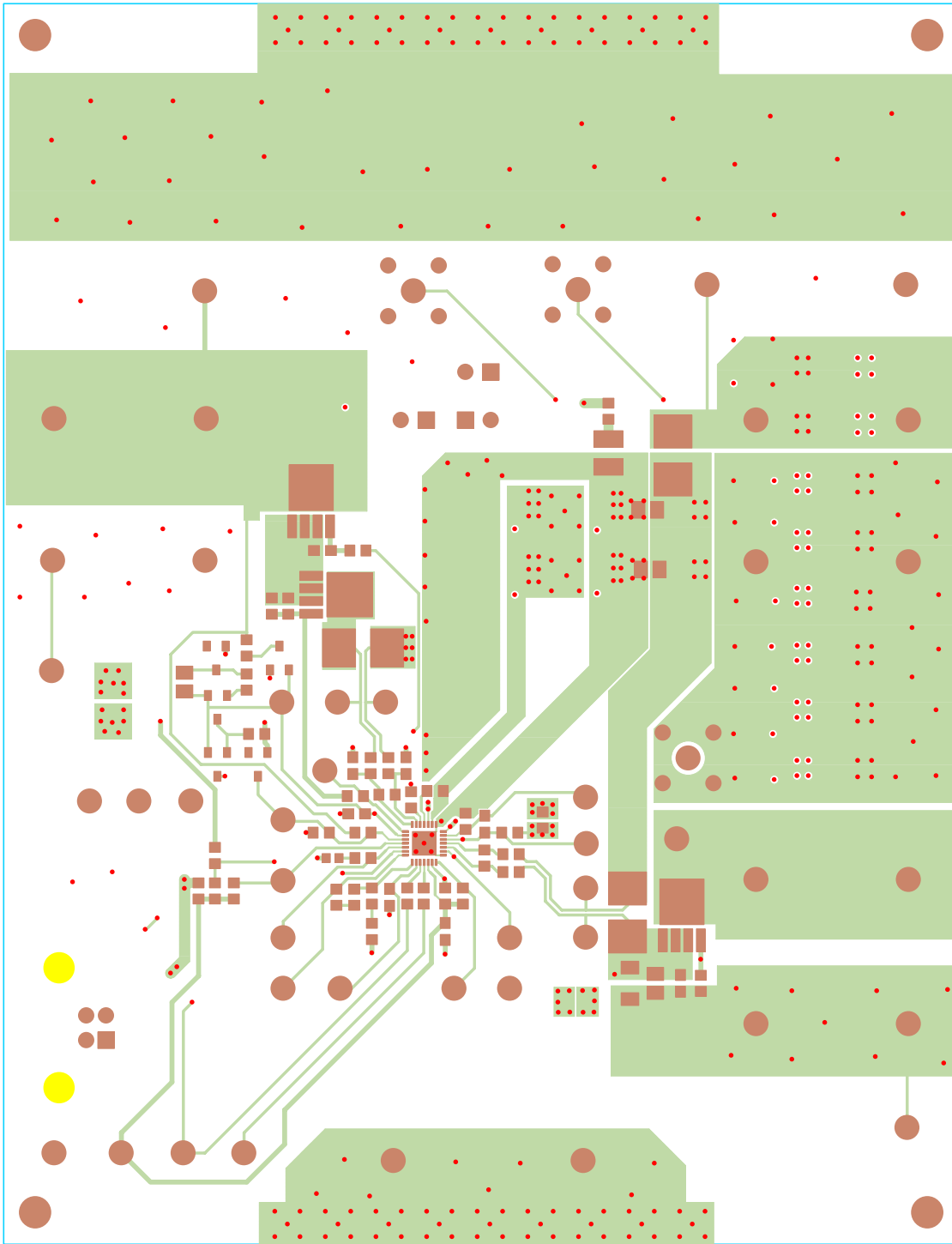

FIGURE 19. TOP LAYER COPPER

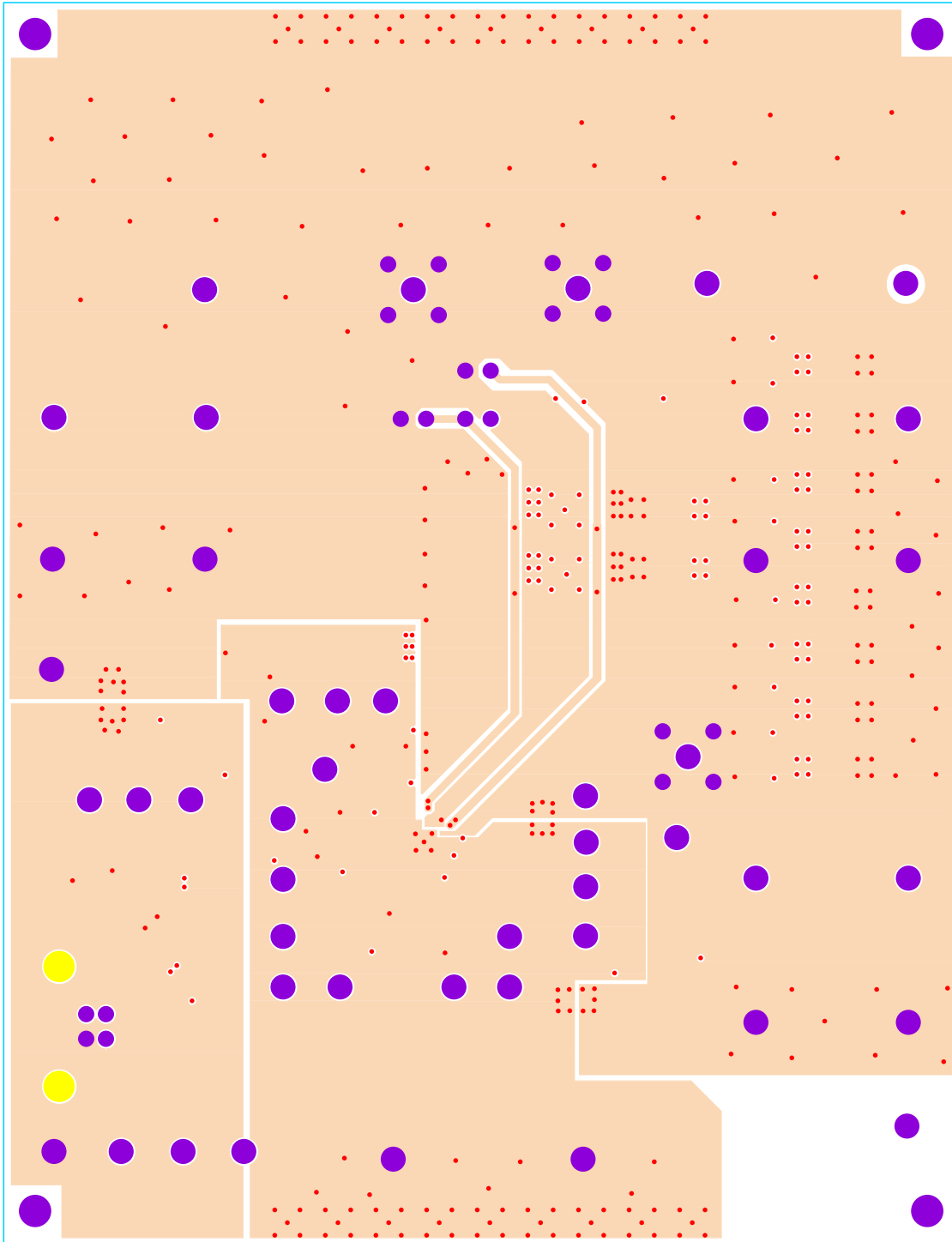

FIGURE 20. LAYER 2 COPPER

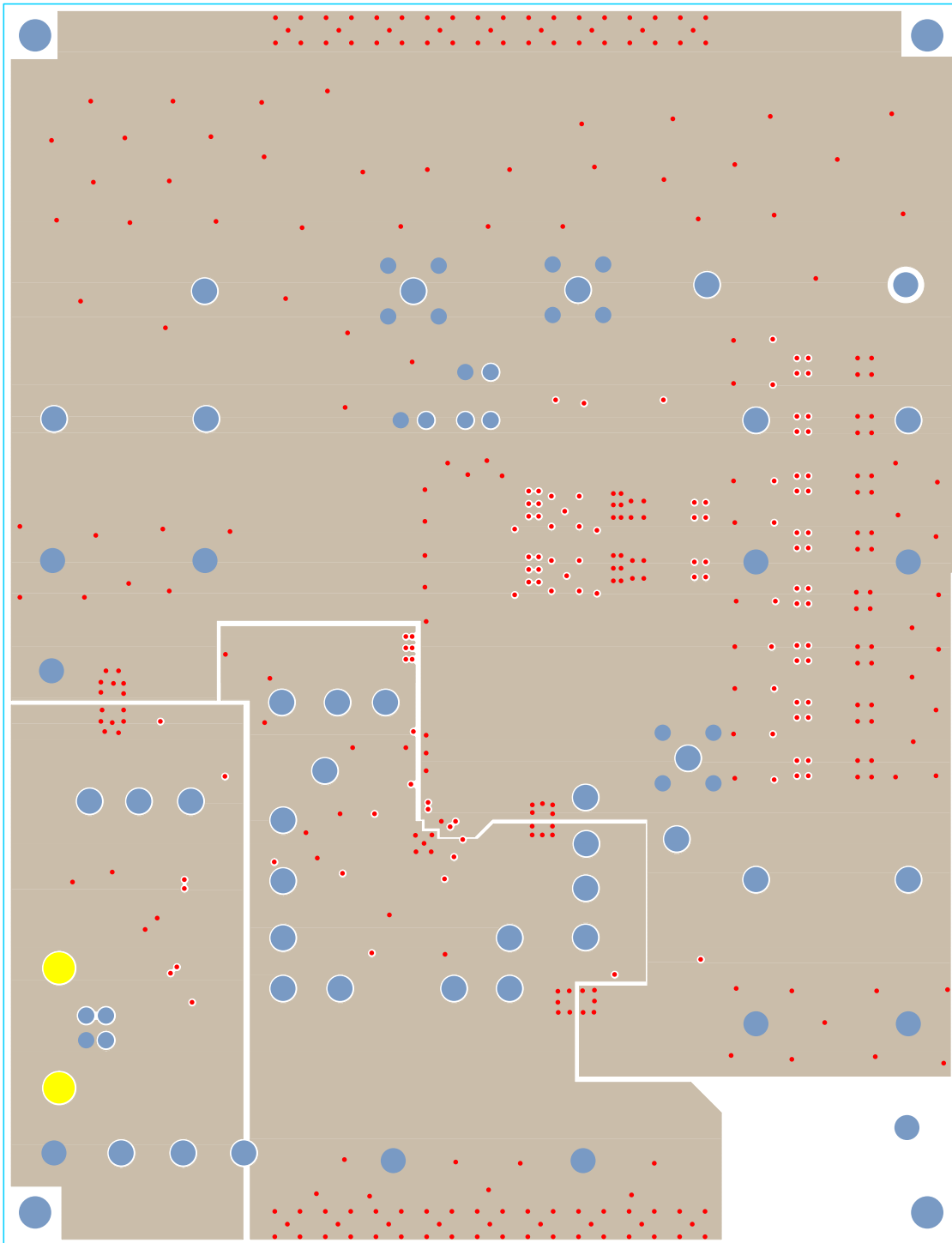

FIGURE 21. LAYER 3 COPPER

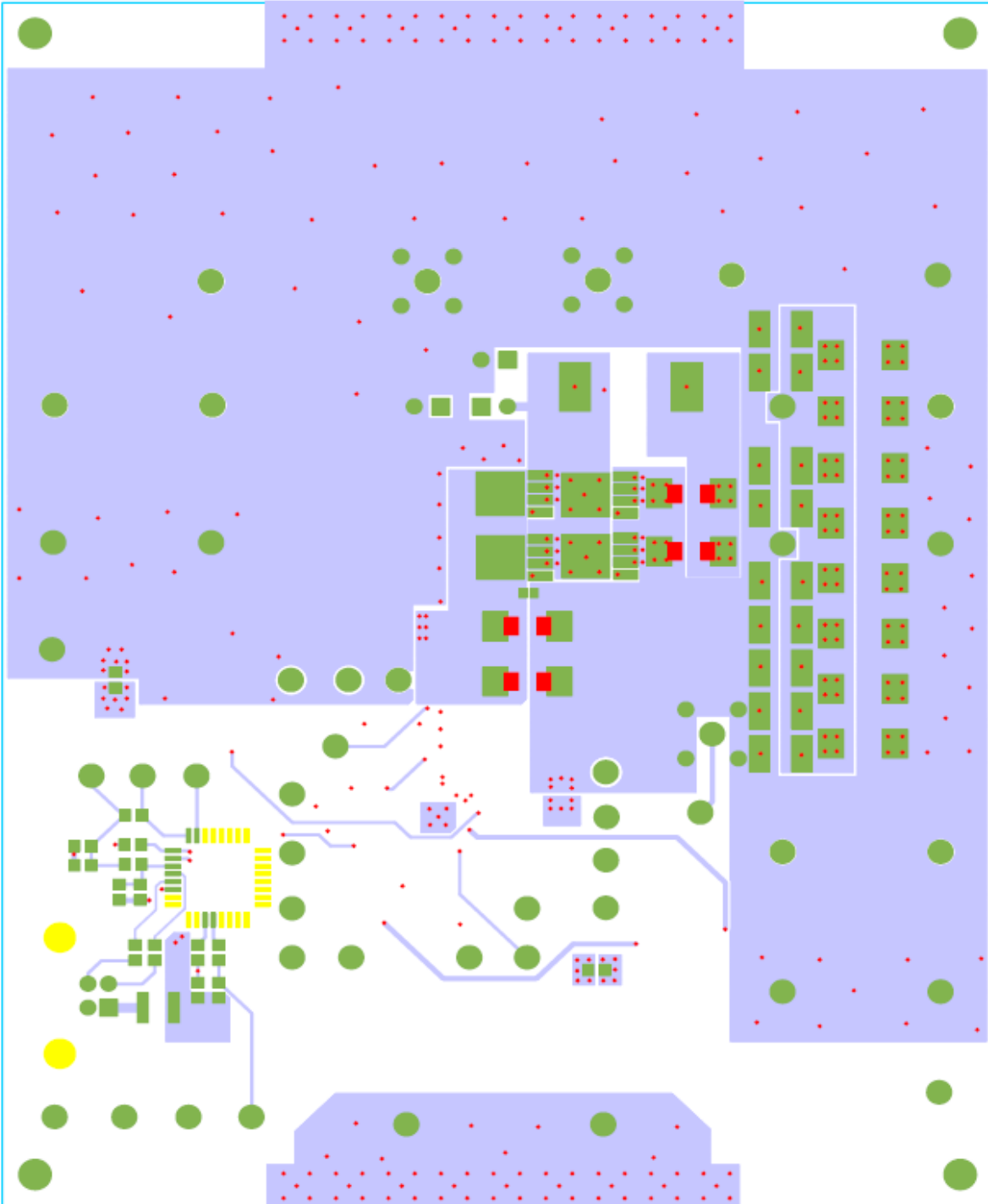

FIGURE 22. BOTTOM LAYER COPPER

Intersil Corporation reserves the right to make changes in circuit design, software and/or specifications at any time without notice. Accordingly, the reader is cautioned to verify that the Application Note or Technical Brief is current before proceeding.

For information regarding Intersil Corporation and its products, see www.intersil.com